

Customer Information

Customer:	Date:
Contact:	Order No.:
Drawing No.:	Part No.:

Sensor Information

Application:	Liquid Type:	
Resistive Output Values:	Empty:	Full:
	European	to
	US	to
	Other:	to

SAE 5-Hole Mounting

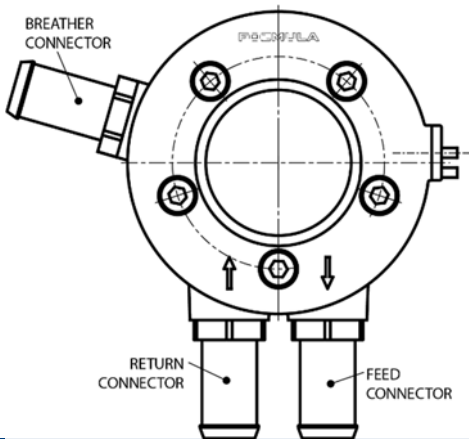

SAE 6-Hole Mounting

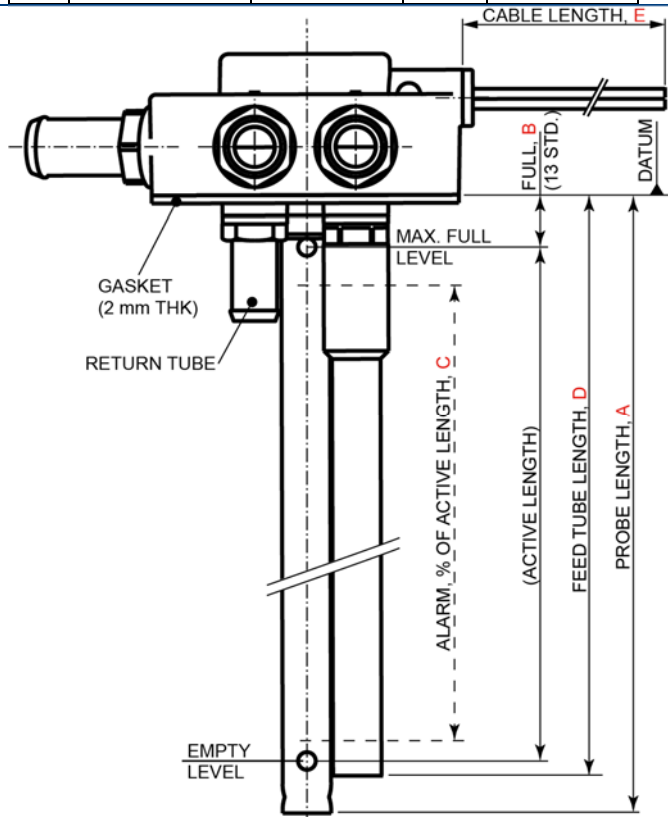
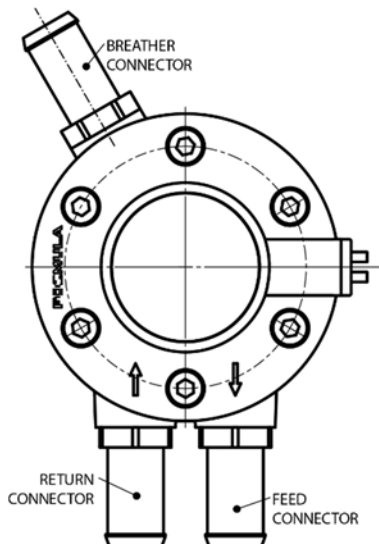





Probe Length, A	
Full Level, B	
Alarm Point (% of Active Length), C	
Alarm Type (Standard Close on Fall)	
Feed Tube Length, D	
Return Tube	
Cable Length, E (Includes connector length - if fitted)	

Bespoke Feed Tube Part No.:

Notes:

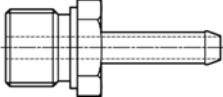
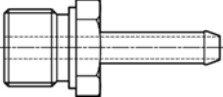
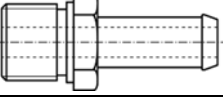
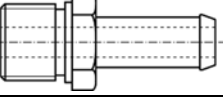
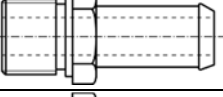
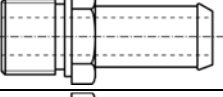
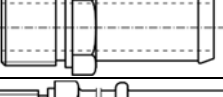
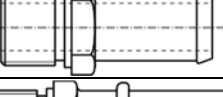
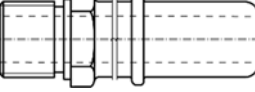
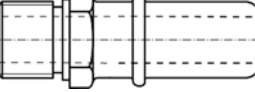
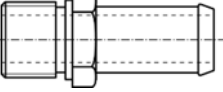
Notes:

Feed Connector		Return Connector	
Blanking Plug		Blanking Plug	
Ø4.5		Ø4.5	
Ø6.5		Ø6.5	
Ø8.0		Ø8.0	
Ø10.0		Ø10.0	
Ø10 J2044 Supply		Ø10 J2044 Return	
Other Feed Connector - provide details: (Fittings with M16x1.5 thread & suitable sealing)		Other Return Connector - provide details: (Fittings with M16x1.5 thread & suitable sealing)	
Breather Port			
Ø10.0		Blanking Plug	
Other Breather Port - provide details: (Fittings with M16x1.5 thread & suitable sealing)			
Accessories			
Cable Termination:		Suction Pipe Filter:	

For Fozmula Use				
Cutting Lengths		Action	Initials	Date
Outer Tube:	Inner Rod:	Completed by:		
Feed Tube:	Cables:	Engineering Approval:		
Return Tube:		BOM/Method Created:		
Fozmula Part No:		BOM/Method Approved:		
Notes:				